

FIG. 3.

7) Repeat the step to attach the other End Apron to the Side Aprons (#1).

8) Place two Support Braces (#4) on Playfield (#3) as shown in FIG. 3. Attach them using two of Washer Head Screw (#13) per side. See FIG. 3.

FIG. 4.

9) Put Hand Grips (#21) and End Caps (#22) on the player rods in order. NOTE: To make the Handles easier to attach, spray a little windowcleaner on the rod ends prior to installation and tap on gently with a hammer. See FIG. 4.

10) Attach Goal Boxes (#23) to End Aprons using five of Washer Head Screws (#12) per goal box.

FIG. 3

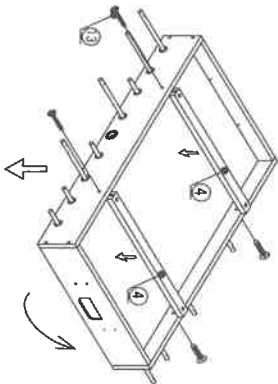

FIG. 4

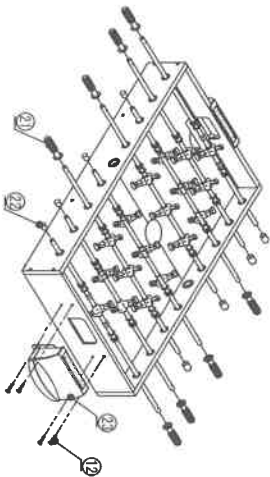

FIG. 5.

11) Attach Left (#7) and Right (#8) Legs to the cabinet using three of Bolts (#10) and three of Washers (#11) per Leg. See FIG. 6.

12) Attach the two End Leg Braces (#9) to the legs using three of Washer Head Screws (#12) per Leg. See FIG. 6.

FIG. 6.

13) Lift the table assembly from the floor with two strong adults, turn it over and set table on its legs in the location where you will play. Go back and make sure that all connections are tight.

FIG. 5

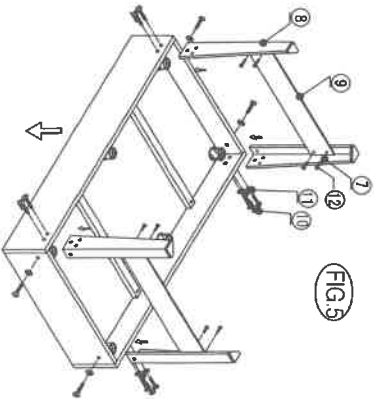
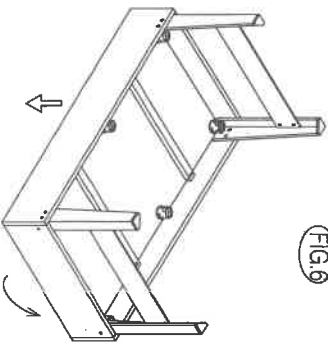

FIG. 6



**CAUTION:** Two strong adults are recommended to flip the table as shown.  
1. Grab the table on the ground.  
2. Turn the table over.  
3. Place it on all four feet at the same time on the ground.

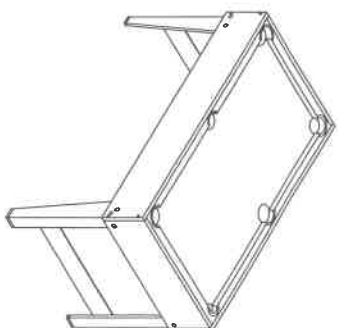
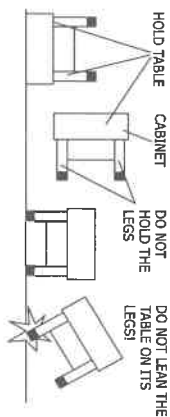
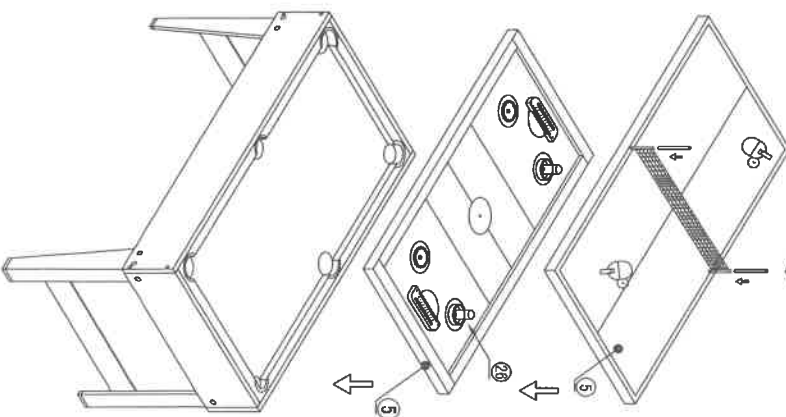
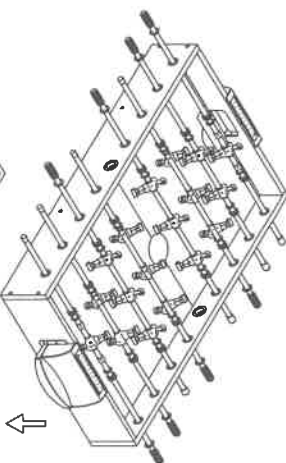
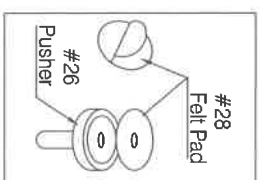

FIG. 7



## ASSEMBLY INSTRUCTIONS:

**We recommend that two adults work together to assemble this game.**

- 1) Open the carton of your new table game near where you will play. Select a clear level floor. This game requires at least two adults to assemble the table.
- 2) Remove all the contents from inside the carton and verify that you have all listed parts as shown on the Parts List.  
**NOTE:** The player rods are pre-assembled. We suggest that you use the bottom carton as a clean flat working area to protect the game. Carefully cut or tear the four carton corners so that the bottom is now your work area.

**FIG. 1.**

- 3) Place one Side Apron (#1) with slotted side facing inward and the finished edge facing down. Slide the Player Rods (#15 through #20) through the Player Rod Bushing in the order shown in FIG. 1. **NOTE:** Make sure that the player rods are installed properly. The players for each team must be facing the same direction.

- 4) Now slide the other Side Apron (#1) over the other ends of the Player Rods with the slotted side facing inward.

**FIG. 2.**

- 5) Slide the Playfield (#3) with graphics facing down as shown in FIG. 2. If the field does not slide smoothly, check to be sure you have not over-tightened any screws or the playfield is not caught by the slot.
- 6) Attach one End Apron (#1) between the Side Aprons (#2) using two of Washer Head Screws (#13) per side.  
**NOTE:** Leave connections loose - Do not tighten screws securely at this time.

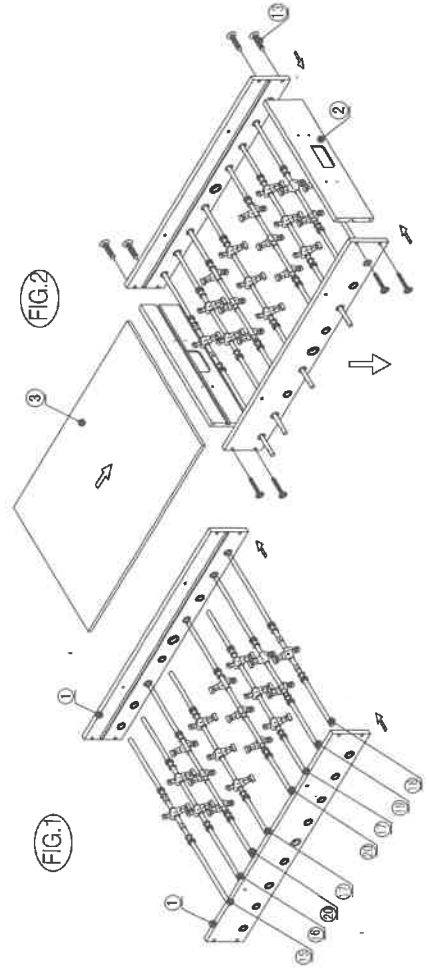









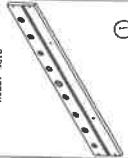

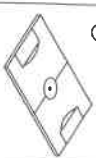

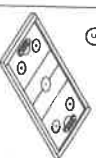
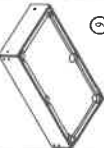















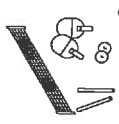

**WARNING** Choking Hazard--Toy contains small balls and/or small parts. Not for children under 3 years.

## IMPORTANT!

**Please Keep Your Instructions.** Before attempting assembly, please read through this instruction book to familiarize yourself with all the parts and assembly steps. We recommend that two adults assemble this game. Please refer to the Parts List below and be sure that all parts have been included.

### PARTS LIST

 1 SIDE APRON ZEA	 2 END APRON ZEA	 1 SOCCER PLAYFIELD 1EA	 4 SHOOT BRACE ZEA	 3 T/HOCKEY PLAYFIELD 1EA	 6 CABINET FOR BILLIARD 1EA
 2 LEFT LEG ZEA	 4 RIGHT LEG ZEA	 3 END LEG BRACE 2 Pieces	 10 SCORING BALL 12EA	 100% GUM WASHER 12EA	 3-EXT/2MM WASHER HEAD SCREW 18EA
 13 3-EXT/2MM WASHER HEAD SCREW 12EA	 1 ALLEN WRENCH 1EA	 15 1 PLAYER ROD ASSEMBLY BLUE 1EA	 16 2 PLAYER ROD ASSEMBLY BLUE 1EA	 17 3 PLAYER ROD ASSEMBLY BLUE 2EA	 18 1 PLAYER ROD ASSEMBLY RED 1EA
 9 2 PLAYER ROD ASSEMBLY RED 1EA	 20 3 PLAYER ROD ASSEMBLY RED 2EA	 21 HAND GRIP 8EA	 22 END CAP 8EA	 23 GOAL BOX 2EA	 24 SOCCER BALL 2EA
 25 TABLE TENNIS NET SET 1SET	 26 HOCKEY PUCKER ZEA	 27 HOCKEY PUCK ZEA	 28 FELT PAD ZEA	 29 BILLIARD BALLS 1EA	 30 CUE STICK ZEA
 31 CHALK ZEA	 32 TRIANGLE 1EA	 33 BRUSH 1 Piece			



# MODEL#SUM4824-4K

## 4 IN 1 COMBO TABLE INSTRUCTIONS

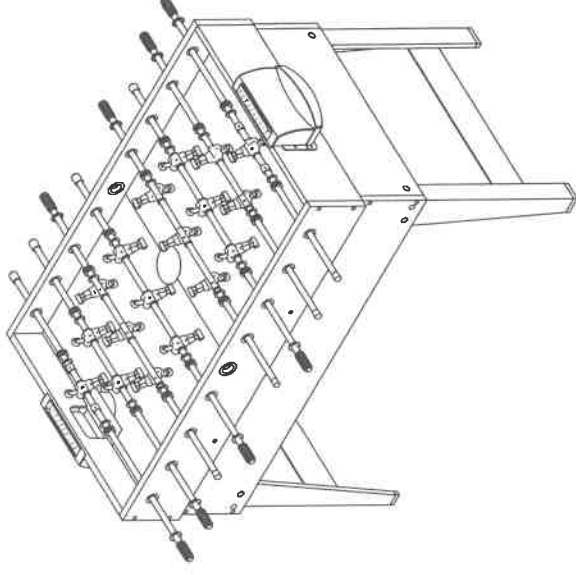

.Assembly Instructions      .Parts List